

Onplana D11 CDP19 4000-830 ET 26

TOC: 6983740

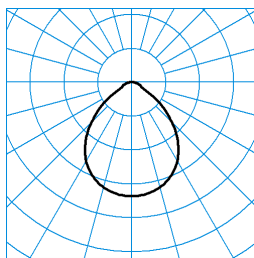

TX054999
 UGR I = 19.2
 UGR q = 19.2
 DIN 5040: A50
 UTE: 1,00 C

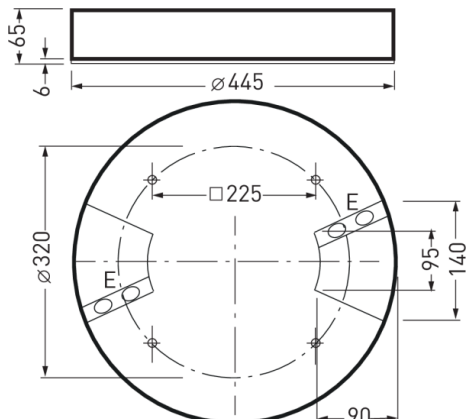

Offer text

Round surface-mounted LED downlight, Construction height 65 mm. For wall and ceiling mounting. With primary reflector highly efficient CDP microprismatics. Direct glare limitation in accordance with $UGR \leq 19$. VDU-compliant lighting in compliance with EN 12464-1 via limited luminance $L = 3000 \text{ cd/m}^2$ for beam angles above 65° all round, for computer screens with positive polarity and self-luminance greater than 200 cd/m^2 . With mainly direct light distribution. Decorative ceiling illumination also softens contrast on the ceiling. Harmonious light effect due to homogeneously illuminated light emission. Luminaire luminous flux 3800 lm, connected load 39 W, luminous efficiency of luminaire 97 lm/W. Light colour warm white, correlated colour temperature (CCT) 3000 K, general colour rendering index (CRI) $R_a > 80$. Mean service life $L80(t_q 25^\circ\text{C}) = 50,000 \text{ h}$. Luminaire body of die-cast aluminium. Luminaire body anthracite black structure-coated. Luminaire diameter $\varnothing 445 \text{ mm}$, luminaire height 65 mm. Permissible ambient temperature (t_a): $-20^\circ\text{C} - +25^\circ\text{C}$. Safety class (EN 61140): I, protection rating (DIN EN 60529): IP40, impact resistance level in accordance with IEC 62262: IK02/0,2 J, testing temperature of wire glow test in accordance with IEC 60695-2-11: 650°C . With connection terminal to 2.5 mm, cable strain relief and mains through-wiring. Weight 4,6 kg. The luminaire complies with fundamental requirements of applicable EU regulations and product safety legislation and bears the CE symbol. The luminaire is also ENEC-certified by an independent testing authority.

Product features and key data

Luminaire type	Round surface-mounted LED downlight, Construction height 65 mm.
Mounting method	Surface-mounting
Luminaire optic	With primary reflector highly efficient CDP microprismatics.
Connected load	32 W
Colour temperature	3.000 K
Rated luminous flux	3.800
Light output ratio	1
Luminous efficacy	97,4 lm/W
Colour rendering index	80
Luminaire colour	DB703 micaceous iron oxide
Luminaire body	Luminaire body of die-cast aluminium.
Connection method	Terminal
Touch-Dim-capable	No
Emergency light	without emergency light
IFS label	No
Ingress Protection (IP) rating	IP40
Protection rating on room side	IP40
Protection class	I
Impact resistance (IK)	IK02
Hot wire resistance	650 °C
Net height	65 mm
Outside diameter	445 mm
Weight	4,6 kg

Available accessories

Material	Description
6984400	Onplana D11 ZS 3075/2000 01
6984500	Onplana D11 ZS 5075/2000 01
6987600	Onplana D11 ZIP54 01